

OVERVIEW

GALILEO - MDS2
RING SPINNING FRAME

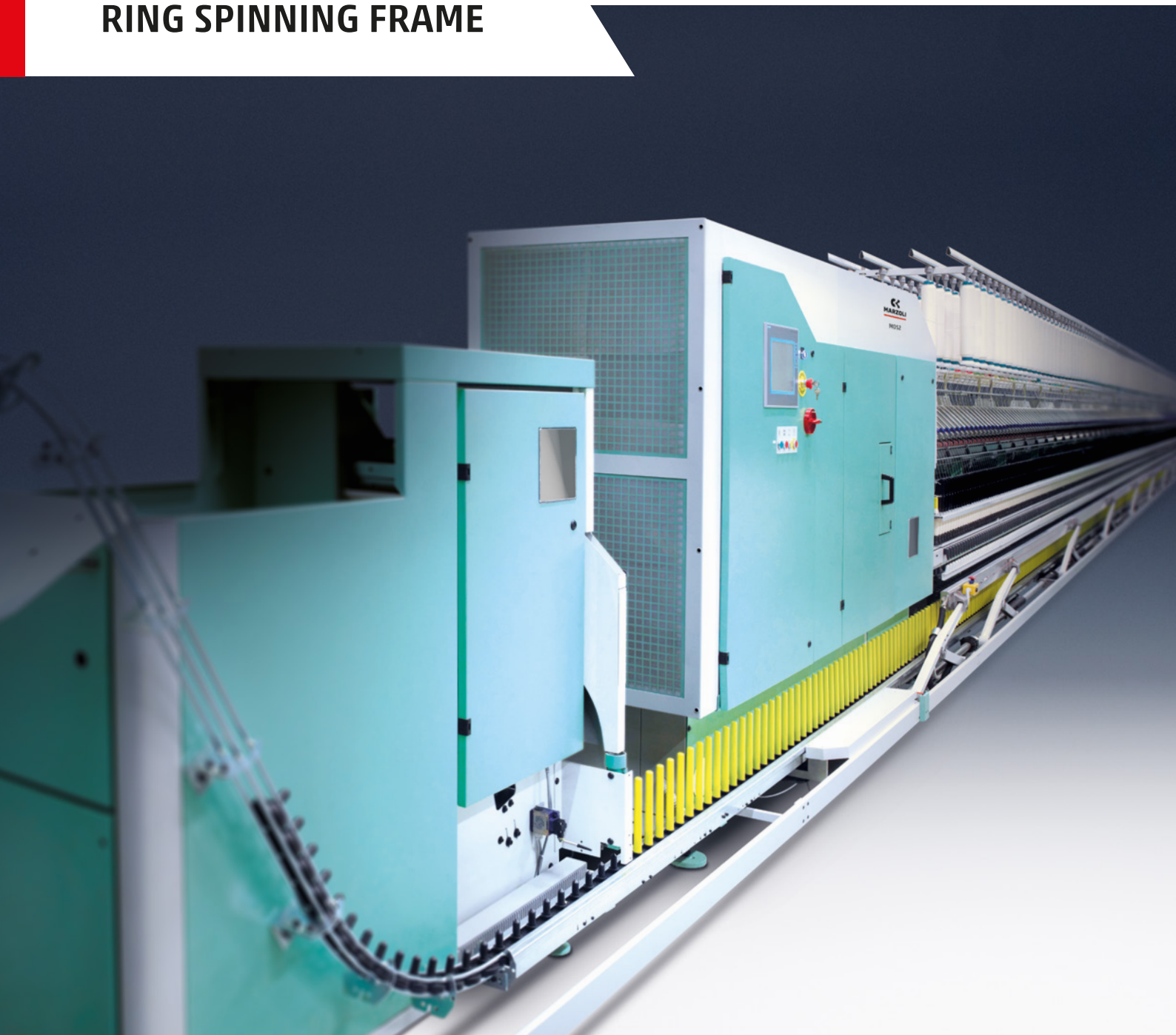

Marzoli

Complete spinning line,
components and digitalized
solutions for the best performance
of the spinning process



THE ONE SOURCE FOR A FULLY-AUTOMATED AND DIGITALIZED SPINNING MILL

Marzoli, one of the major brands of the textile sector worldwide, is a unique European manufacturer of the complete line of machines for the opening, preparation and spinning of short-staple fiber. From the bale opener to the ring spinning frame, Marzoli offers the most advanced technology for a completely-automated spinning mill. Through its global sales and service network, its expertise on each type of fiber and application and the competence on the entire process, Marzoli represents a competent and reliable partner. And through its experience, know-how and commitment, it provides its customers with:

- Advanced spinning solutions through a careful activity of textile engineering. Marzoli assists its customers from the study of the spinning plan, throughout sourcing, erection and commissioning, up to maintenance of the resulting turnkey spinning plant, which can comprise Marzoli but also third-party machinery. The customer can rely on the competence and capability of a unique partner, responsible for the quality and productivity of the entire spinning mill.
- The advantages of smart spinning. No matter what the brand(s) of the machinery is, Marzoli can install its software platforms, YarNet and MRM, its hardware applications for gathering data on waste percentages and its composition, quality values, productivity indexes and other kpi data to let the customer build on the potential of Industry 4.0, optimize the entire spinning process through well-informed decisions and reach the highest performance in production operations.

OVER
170 YEARS
OF SUCCESSES

OVER
70 COUNTRIES
WITH ACTIVE CLIENTS



OPENING SECTION

- Openers & Cleaners
- Mixers & Blenders
- Card

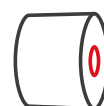

COMBING SECTION

- Draw Frames
- Lap Winder
- Comber
- Lap Transport



SPINNING SECTION

- Roving Frame
- Ring Spinning Frame
- Bobbin Transport System

GALILEO MDS2 RING SPINNING FRAME

Advancements in spinning frame technology

KEY POINTS

- FULLY ELECTRONIC MACHINE UP TO 2,400 SPINDLES
- GREAT ENERGY SAVINGS
- LOW MAINTENANCE
- GREAT PRODUCTIVITY
- HIGH FLEXIBILITY
- BUILT IN FANCY YARN DEVICE
- COMPACT YARN APPLICATION



In recent decades technological progress of ring spinning frames has been restless. Product innovations have allowed to produce new types of yarn (e.g. compact yarn), to increase output volumes and to lower investment and operating costs. Marzoli MDS2 spinning frame sets the lead in this process of continuous technological advancement, pursuing the objectives of productivity, efficiency and flexibility. The MDS2 ring spinning frame is a fully electronic frame with independent drives for spindles, the ring rail and the drafting system. The electronic coordination of these drives ensures the perfect synchronization of all working organs with a drastic reduction of mechanical transmission. This entails less friction, fewer vibrations and fewer transmission organs (e.g. gears, pulleys, shafts) with **substantial savings** on energy consumption and maintenance costs (fewer transmission organs require less lubrication and a big economic advantage for the spare parts department). Marzoli spinning frame also scores very high on **productivity**.

The MDS2 spinning frame can work at higher speeds and can be equipped with up to 2,400 spindles. This allows customers to produce the same quantity of yarn with fewer machines and benefit from substantial **investment savings**.

The MDS2 spinning frame guarantees high **flexibility** too. All technological parameters (count, S or Z twist, bobbin build, speed) are set directly on the touch screen and all the production recipes can be stored and recalled at any time, saving time during lot changes. Moreover, the particular geometry of the feeding creel, the integrated slubbing device and the new compact application allow to produce any type of yarn: Lycra, core-spun, double roving, slubbed and compact. All these upgrades can be easily installed and perfectly integrate with the MDS2 spinning frame, making it one of the most flexible machines available on the market.

MDS2 design features

- Independent drives for spindles, ring rail and drafting system.
- Multi motor drive system for spindles with multi tangential belt; every motor and every belt move up 192 spindles.
- Number of spindles up to 2,400.
- System to drive the bottom drafting cylinders with timing belt.
- Setting of all technological parameters (count, S or Z twist, bobbin build, speed) directly on the touch screen with possibility to save the programs.
- Built-in fancy yarn device.
- New compact yarn application.

SPINDLE SPEED ADJUSTMENT & TUBES GEOMETRY DESIGN TO BOOST PRODUCTIVITY AND EFFICIENCY

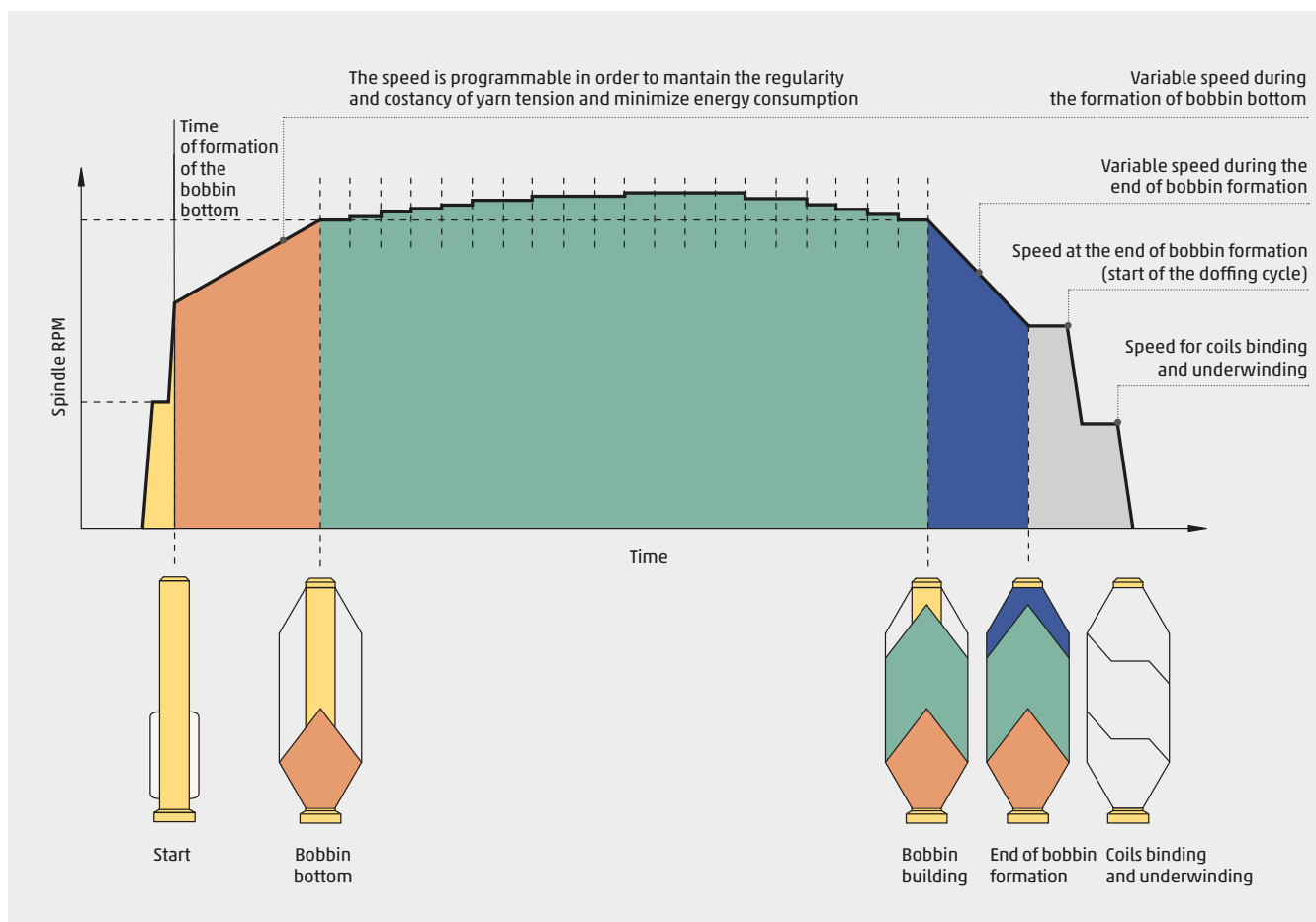

Spindle speed adjustment

The speed of the spindles varies in order to maintain the yarn tension constant. This allows to minimize yarn irregularities and breakages and work at higher speed. In case of power fault the computerized system controls the stop of the machine and avoids yarn breakages.

Tubes geometry

- The high taper value (1:64) of Marzoli tubes allows to wind more yarn and therefore reach a higher cop weight.

MDS2 DRIVING SYSTEM

The MDS2 spinning frame is moved by a set of independent drives for spindles, the ring rail and the drafting system. All these drives are coordinated by state-of-the-art electronics which ensures the perfect synchronization of all working organs with a sharp reduction of mechanical transmission.

■ DRAFTING UNIT

Short drafting rollers to guarantee lower torque and torsion. This entails lower ends down at start-up of the machine, higher acceleration and deceleration performance if slubbing is involved and most importantly no vibrations.

Independent frequency-controlled drives for front roller and middle-rear rollers: main draft set on touch screen.

Middle and rear rollers are connected with timing belts instead of gears. This grants several advantages for customers:

- no lubrication in the drive unit;
- easy maintenance and cleaning;
- less noise;
- high flexibility in setting the break draft value through an interchangeable timing pulley;
- lower inertia for higher production (for slub yarn).

In Marzoli drafting system, the middle and rear drafting rollers are driven by brushless motors.

This entails:

- higher efficiency compared to squirrel cage motors;
- higher precision and performance on acceleration and deceleration ramps (for slub yarns).

KEY POINTS

- INDEPENDENT DRIVES FOR SPINDLES, RING RAIL AND DRAFTING SYSTEM
- SHORT DRAFTING ROLLERS FOR NO VIBRATIONS

This entails substantial benefits for the customer: higher efficiency, thanks to lower mechanical friction, and lower maintenance costs, as fewer transmission organs require less lubrication and fewer spare parts.

Three drafting system configurations, according to the number of spindles:

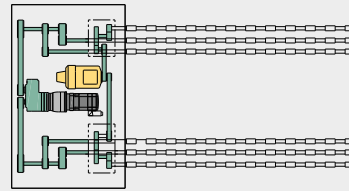

FOR SPINNING FRAMES WITH UP TO 576 SPINDLES

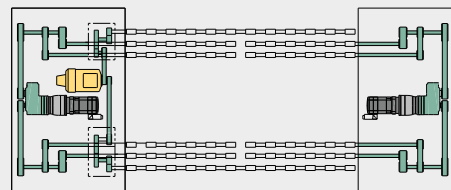

FOR SPINNING FRAMES WITH UP TO 1,200 SPINDLES

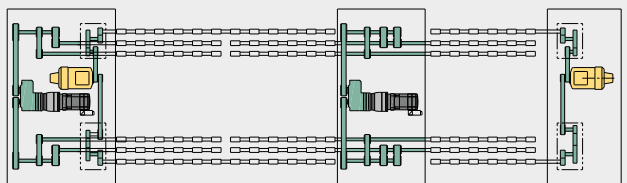

FOR SPINNING FRAMES WITH UP TO 2,400 SPINDLES

■ MSS – INTEGRATED MARZOLI SUPER SLUB

The MSS is Marzoli leading technology designed to obtain the highest performance on quality and speed in the production of slub yarn.

It is the combination of a patented drafting system drive, a purposely designed software with unique features and high-performance electronics. With reference to the drafting system drive, only a very low inertia driving unit ensures steeper and fully-controlled acceleration and deceleration ramps. Existing technologies are using either a heavy gearbox or a low inertia epicyclic gearbox driven by a motor through pulleys and belts. Both systems have high inertia and can not perform

fast and controlled acceleration and deceleration in high speed production.

The picture below show the difference between conventional systems and Marzoli MSS.

The cinematic scheme of Marzoli MSS, motor – epicyclic gearbox – timing belts – bottom rollers, is the solution to reach the lowest possible inertia of the driving components.

This technology enables customers to have no limitation in the shape of the slub and have full control on acceleration and deceleration of the drafting rollers at high production speed.

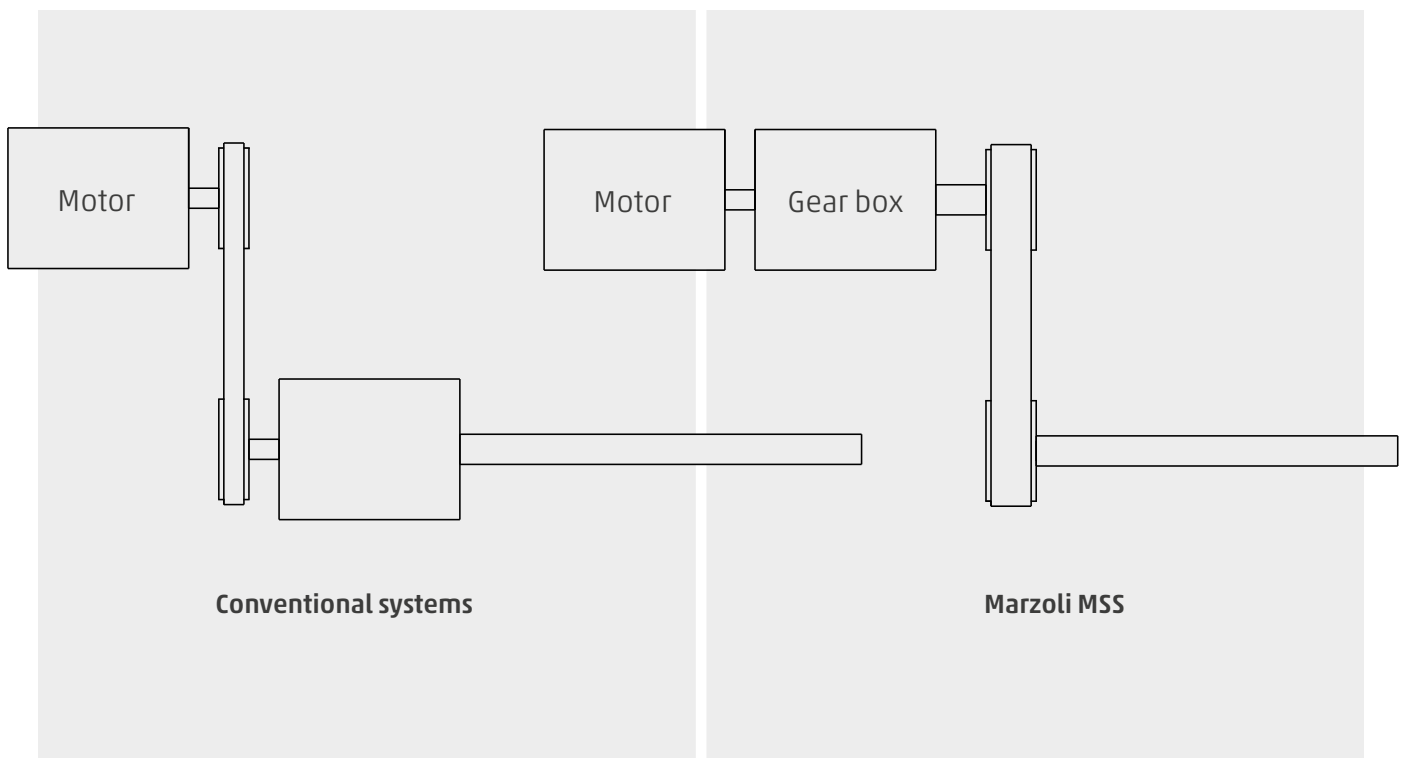

TANGENTIAL-BELT MULTI MOTOR DRIVE

Innovative tangential belt multi motor drive that grants the following benefits:

- less maintenance and cleaner machine: no change of tapes, no tightening pulleys nor shaft;
- better adherence of the belt on the spindle wharve for a speed variation among spindles lower than 1%;
- easier twist change from Z to S and viceversa;
- better thermohygrometric condition along the entire length of the machine: several motors instead of one big motor with the generated heat located at one end of the machine.

Two different configurations for the tangential belt:

1. Multi tangential belt moved by a multi motor drive.
 - All motors connected to one inverter
 - Each motor drives up to 192 spindles.
2. Single tangential belt moved by a multi motor drive.
 - All motors connected to one inverter.
 - Each motor drives 96 spindles.

MULTI TANGENTIAL BELT MULTI MOTOR DRIVE

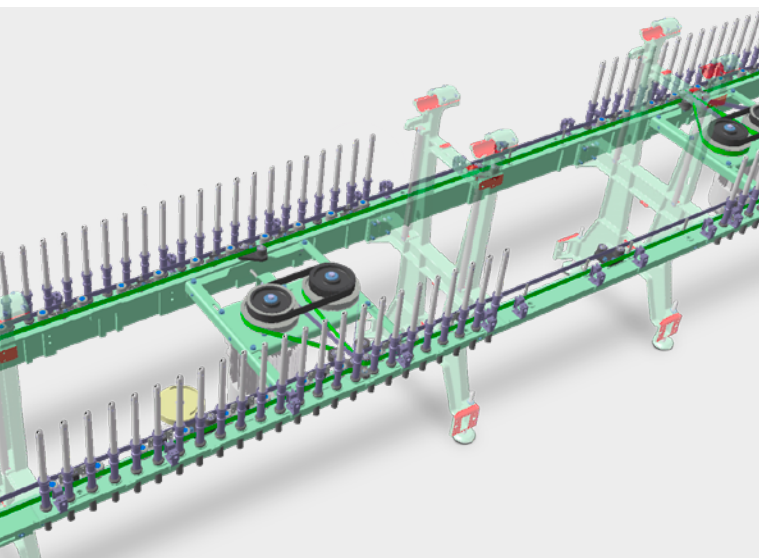

SINGLE TANGENTIAL BELT MULTI MOTOR DRIVE

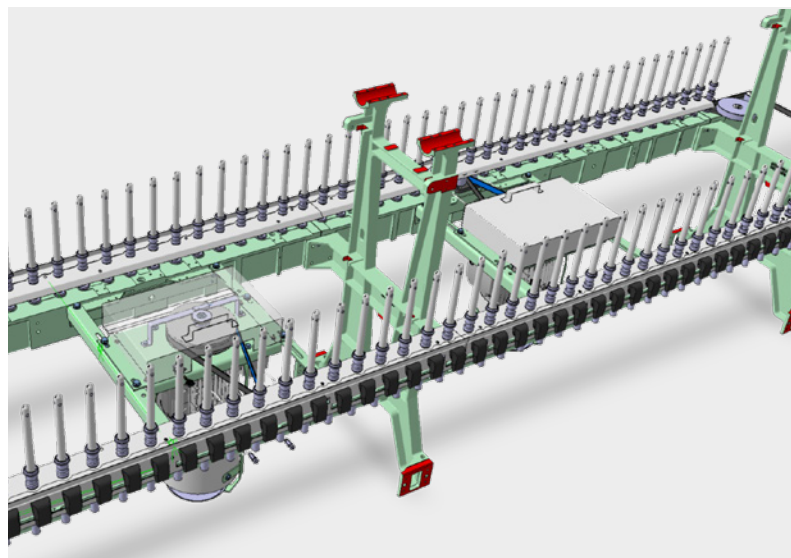

THE MDS2 RING RAIL DRIVE

The MDS2 ring rail drive is a reliable drive without counterweight. This feature permits a better control of the rail during sense inversion and therefore a better winding tension

Moreover, the elimination of the counterweight reduces the deposit of dirt and dust and thus contributes to the easy maintenance and cleaning of the machine.

BROKEN END SUCTION SYSTEM

Marzoli system for broken end suction has one duct with large cross section and flutes. This minimizes the friction of the air flow within the duct with 2 main advantages:

- minimization of energy consumption;
- evener negative pressure at each spinning position.

Competitor solutions have 2 small suction ducts on the sides of the frame and/or single end pipes instead of flutes.

To match Marzoli performance on energy consumption and variability of negative pressure values along the ring frame, on extra-long machines only (on short machines Marzoli solution always grants savings), the standard market solutions need double suction (e.g. one filter box in the head stock and one in the tail stock).

Double suction system (optional)

Beside the substantial energy savings stemming from the large cross section of the suction duct, Marzoli offers the double-sided suction system with one filter box in the head stock and another one in the tail stock. This solution reduces the air flow speed along the machine.

The benefits are:

- almost constant negative pressure on all spindles;
- reduction in energy consumption up to 60% compared to the systems with double suction and 2 small ducts.

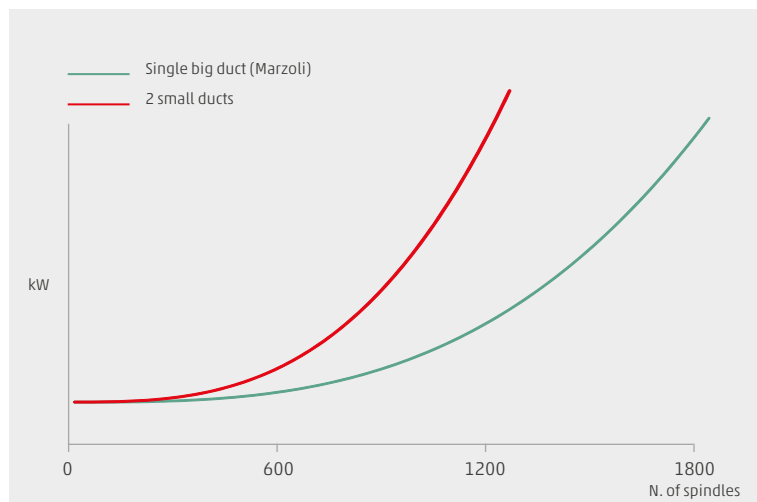
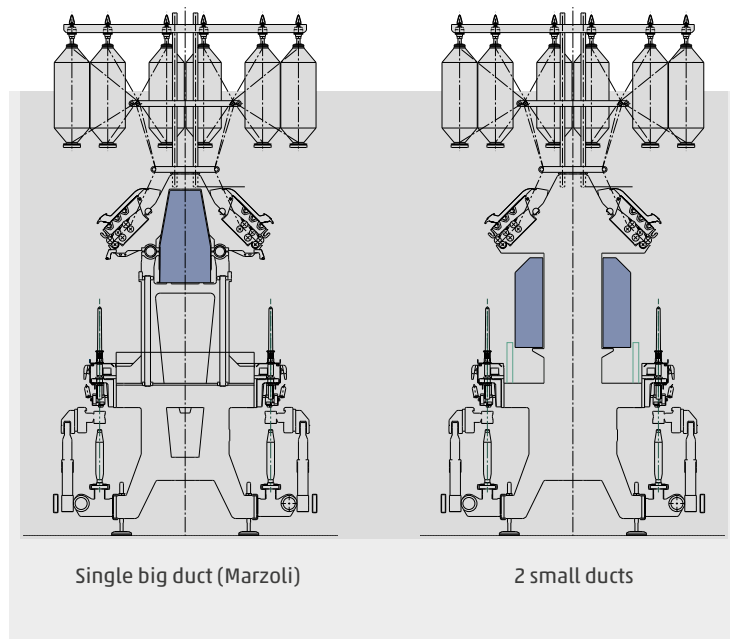

Comparison on energy consumption between Marzoli and competitors solutions.

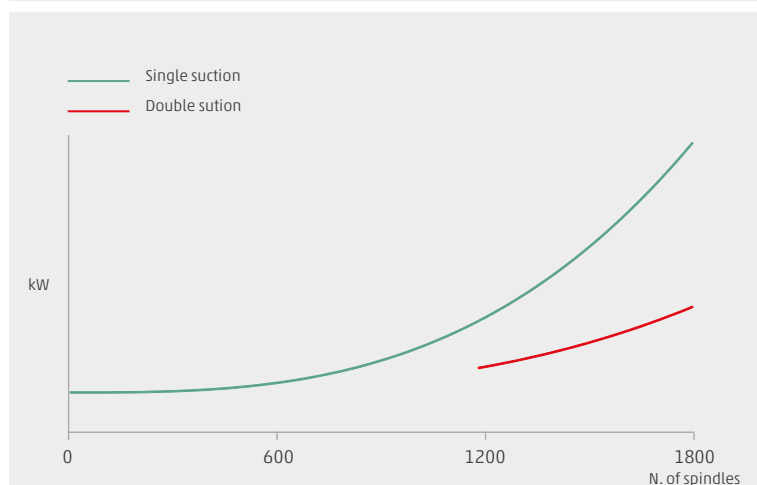

Comparison on energy consumption between single suction and double suction system.

FULL AUTOMATION

The MDS2 spinning frame relies on leading-edge automation in order to boost productivity and reduce labor costs associated with labor intensive activities.

Reliable and fast automatic doffing

As during doffing cycles the spinning frame remains idle, shorter and less frequent doffing cycles entail higher productivity.

The MDS2 spinning frame undertakes a reliable automatic doffing in almost two minutes.

Thanks to the parking rail, the peg tray never host empty tubes and full cops together at the same time. Full cops can reach a bigger diameter which results in fewer doffing cycles and consequently higher productivity not just on the spinning frame but also in downstream operations.

The MDS2 doffing process is carried out as follows:

- empty tubes are transfer red from the peg trays to the parking rail;
- when cop build up is complete, the yarn is wound around the underwinding position and the machine stops automatically;
- full cops are removed from the spindles and transfer red to the peg trays;
- empty tubes are moved from the parking rail to the spindles;
- the machine restarts automatically.

Minimum number of ends down at start up

Special advanced settings of the machine allow to minimize the ends down at start up.

KEY POINTS

- AUTOMATIC DOFFING IN ALMOST 2 MINUTES
- FEWER DOFFING CYCLES
- SAVINGS ON LABOR COSTS
- HIGHER PRODUCTIVITY & EFFICIENCY



■ UNDER COIL CLEANING SYSTEM

To cut the thread reserve, there is a simple metallic cutter which cuts the yarn when the blower pushes it against the spindle.

The thread reserve is cut in small pieces and then scattered on the floor. This solution works well for medium and fine yarn.

An alternative solution for the removal of the thread reserve is the Wondercleaner. The Wondercleaner is a suction unit attached to the blower that cuts and sucks the thread reserve.

It works only between doffing cycles, when the ring rail has reached a minimum height. After the cleaning is performed, the suction activity remains idle.



■ ZERO COIL BINDING

Zero coil binding is an alternative solution for the reduction of yarn consumption, fiber fly and consequently ends down and the risk of contamination.

The system, installed on the spindle underwinding position, clamps and releases the thread reserve.

The closing and opening of the crown is triggered by spindle speed.



EASY, FAST & EFFICIENT MAINTENANCE & CLEANING

KEY POINTS

- EASY ACCESS TO ALL MAIN COMPONENTS AND DRIVES
- SMART SOLUTIONS TO KEEP THE MACHINE CLEAN

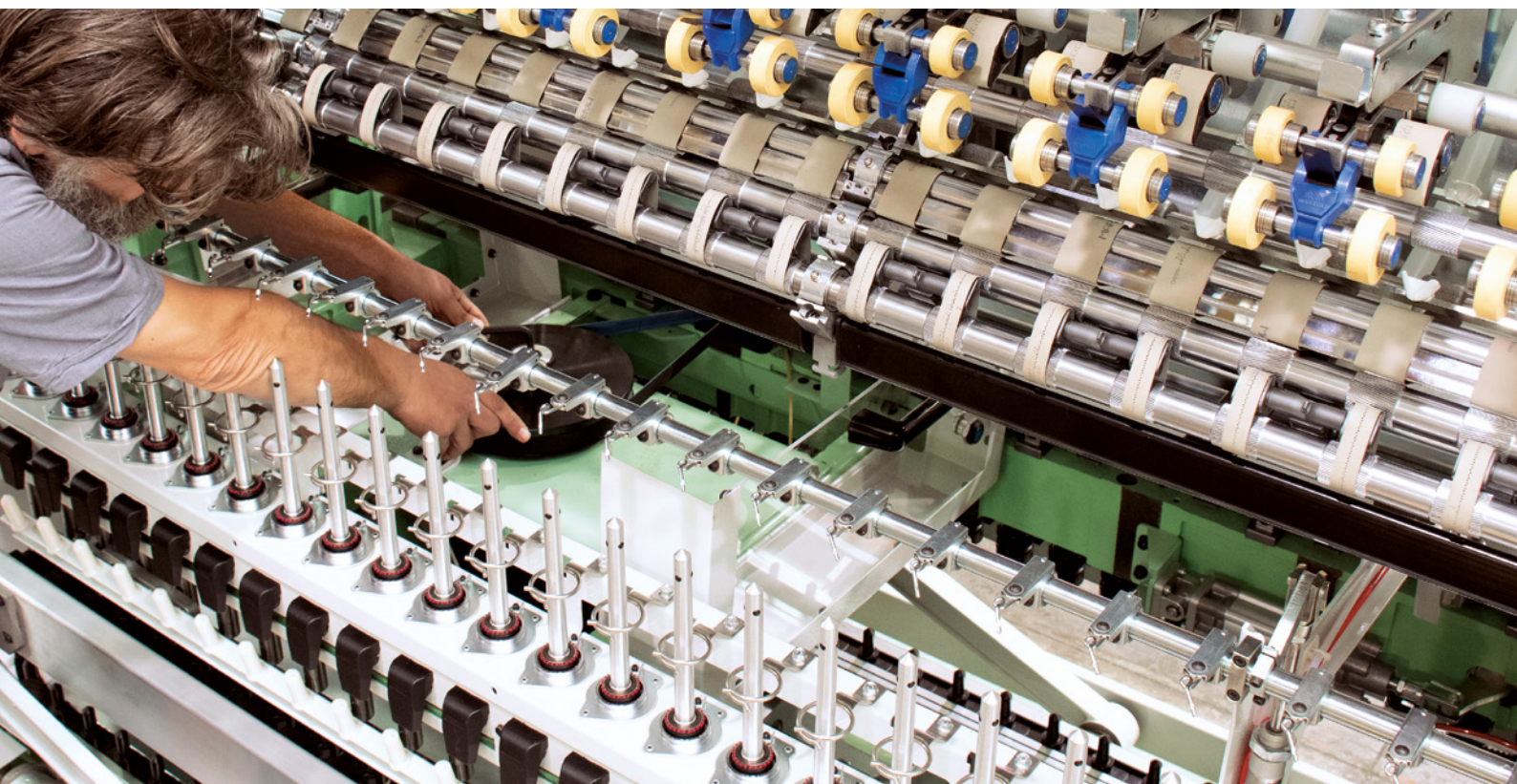

MDS2 allows spinners to benefit from easy maintenance which entails low downtime and cost savings.

Cleaning and maintenance:

- easy access to all the motors and driving components;
- automatic cleaning action of tighteners and spindle pullies;
- no fiber and dust accumulation on the motors of the spindle drive;
- easy access to all components of the drafting system drive;
- easy access to electrical components.

POWER CONSUMPTION: MDS2 SPINNING FRAME

The various phases of product development - design, development, production, and utilization - are driven by Marzoli's efforts to create and offer equipment with low energy consumption.

Marzoli aims at reducing the environmental impact of its productive processes during all phases of the equipment life cycle, starting from production to their use within the client's plants.

REDUCTION IN POWER CONSUMPTION IN THE LAST 20 YEARS NE 30

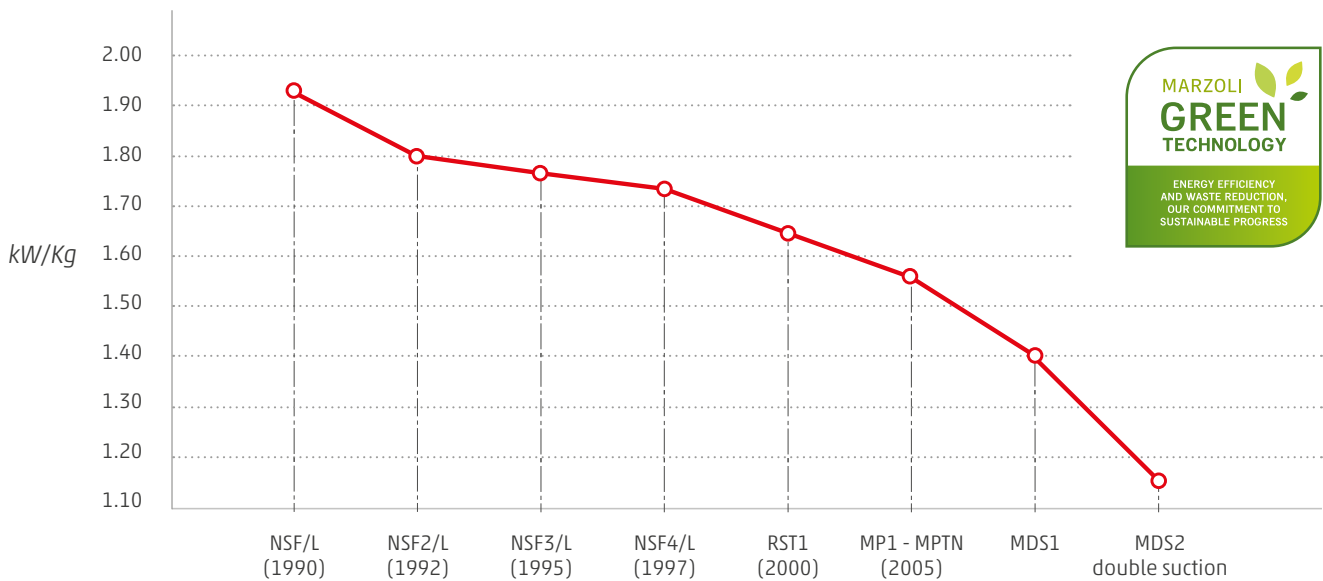

MDS2 power consumption					
Yarn Count Ne		10	30	40	60
Speed Rpm		10,000	17,500	18,000	19,000
Production gr/sp/h (100% efficiency)		69.4	24.6	19.4	8.4
kW/kg (suction and blower included)		0.38 - 0.44	1.24 - 1.42	2.27 - 2.63	3.58 - 4.15

The Kw/Kg values may vary according to the operational conditions of the machines.

ADVANCED YARNS

FANCY YARN

As contribution margins for conventional yarn shrink, spinners tend to upgrade their productions to fancy yarns. Marzoli MDS2 onboard technology gives the possibility to produce any fancy yarn effect (slub, multitwist, multicount, reverse slub) and every possible combination for a virtually unlimited range of designs. All it takes to start the production of fancy yarns is an update of the software: no mechanical modification nor attachment to the machine is needed. The purposely designed and user-friendly software and

KEY POINTS

- HIGHER QUALITY AND PRODUCTIVITY PERFORMANCE ON SLUB YARNS THROUGH MSS
- STATE-OF-THE-ART COMPACT SYSTEM FOR ANY TYPE OF FIBER

the patented low-inertia drive for the drafting system, MSS (Marzoli Super Slub), allow to obtain:

- effects that are not achievable with competitor machines;
- to obtain the same effects of competitor machines with higher production speeds;
- no thin points at the end of the slub thanks to a better control of the acceleration and deceleration of the drafting rollers.

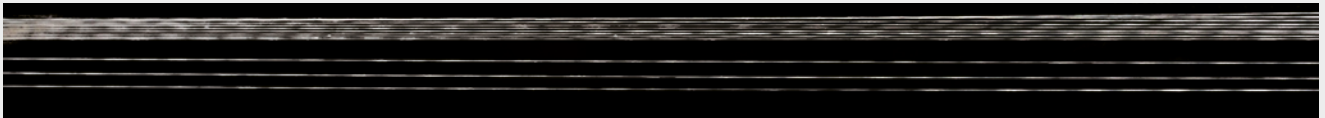

1 m



The picture above shows the result of one of our tests:

- 37 slubs in one meter
- multiplier 2.5
- @ 16.5 m/min
- 610 slubs per minute

CORE-SPUN YARN

The MDS2 spinning frame can be equipped for the production of core-spun yarn with any type of core filament (elastic, rigid or semi-rigid) and with any type of covering fiber (natural, artificial or synthetic), duocore yarn and double-roving spun yarn.

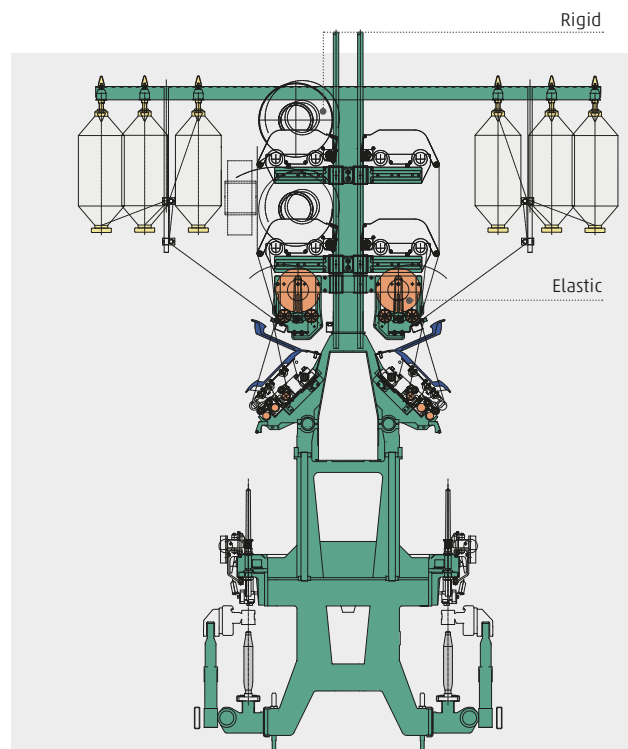

COMPACT YARN

Marzoli MDS2 can be equipped with compact technology to reduce the width of the spinning triangle and, consequently, let the spinner benefit from:

- reduced hairiness;
- evenness enhancement;
- higher tenacity;
- lower required twist on the spinning frame (higher production);
- high weaving/knitting speed and efficiency;
- enhanced fabrics properties (fabric strength, abrasion resistance, pilling behavior, visual and tactile features)

Standard Yarn

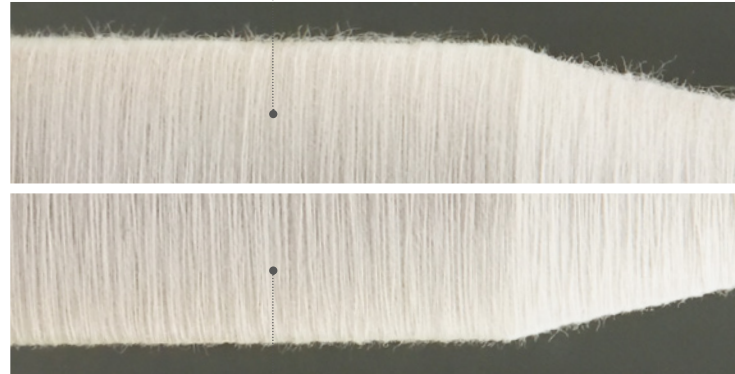

Mac3000 Compact Yarn

COMPACT SYSTEM MAC3000

Marzoli MAC 3000 is a cutting-edge apron-compacting system capable of reaching outstanding yarn quality results.

Its main features are:

- extra-long compacting area;
- independent suction system with auto cleaning system, constant suction at each spindle position and low energy consumption;
- frequency-controlled motor fan to set the right negative pressure according to the type of fiber and yarn count;
- auxiliary cylinder (cylinder zero) driven by independent brushless motor. Draft ratio in the compacting area can be set for the best quality results;
- visible compacting area, easy maintenance;
- self-cleaning aprons;
- designed for quick installation, it allows the transition from machine without compact system to machine with compact system in an extremely easy way.



TECHNICAL DATA

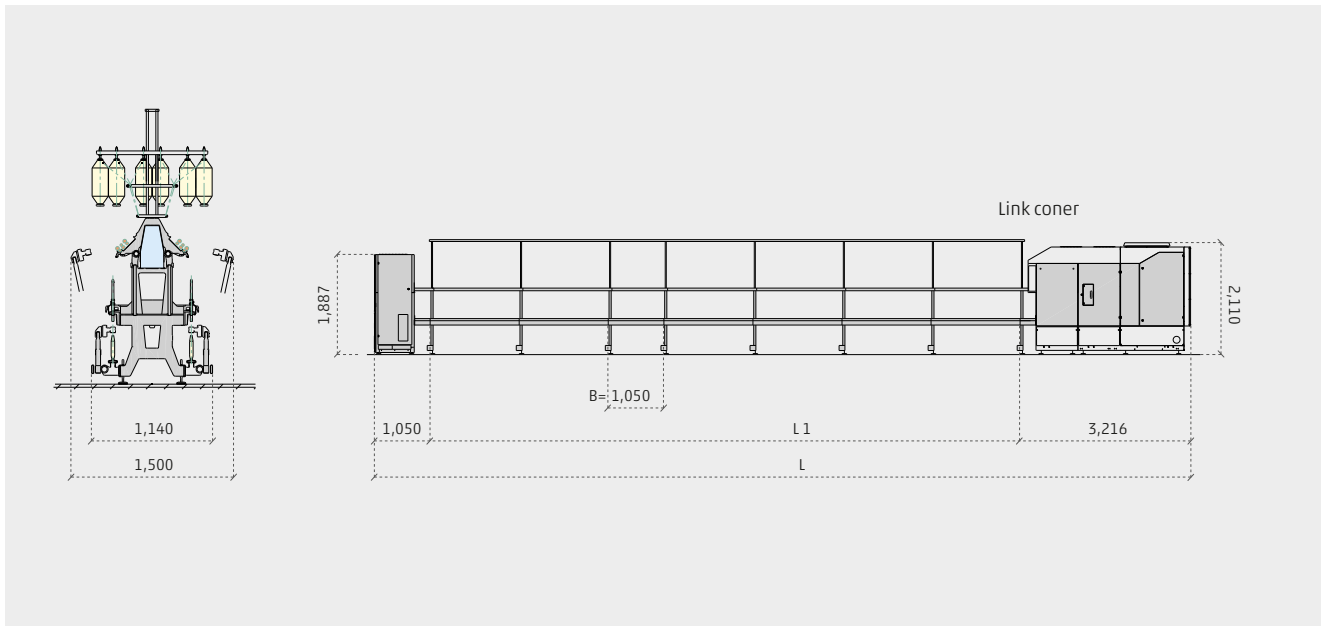

MDS2 with link to cone winder

Up to 1200 spindles

From 1248 to 2,400 spindles

$L1 = (\text{spindles per machine}/2) \times \text{gauge}$

$L1 = (\text{spindles per machine}/2) \times \text{gauge} + B$

$L2 = L1 + 4266$ (One sided suction)

$L2 = L1 + 5066$ (Double-sided suction)

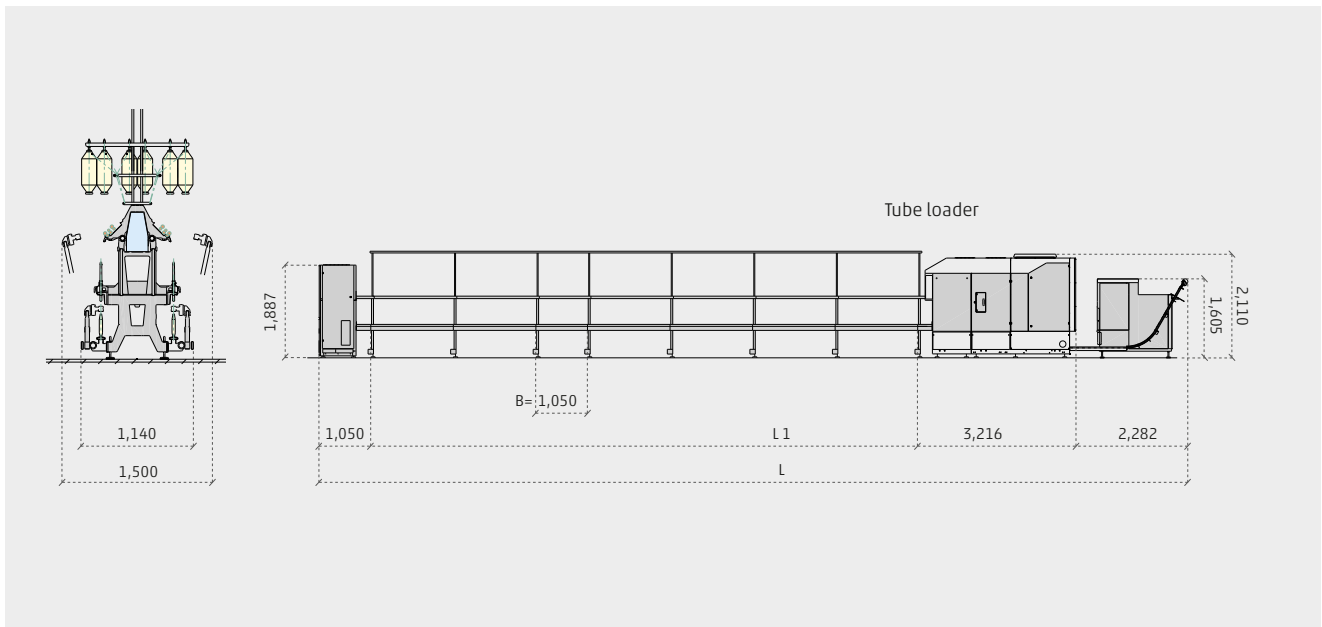

MDS2 with automatic tube loader

Up to 1200 spindles

From 1248 to 2,400 spindles

$L1 = (\text{spindles per machine}/2) \times \text{gauge}$

$L1 = (\text{spindles per machine}/2) \times \text{gauge} + B$

$L2 = L1 + 6548$ (One sided suction/gauge 70)

$L2 = L1 + 7348$ (Double sided suction/gauge 70)

$L2 = L1 + 6586$ (One sided suction/gauge 75)

$L2 = L1 + 7386$ (Double sided suction/gauge 75)

MDS2				
Material	Carded and combed cotton man-made fibers and blends, up to 60 mm			
Yarn count range	Ne 4 - Ne 350 / Nm 6 - Nm 678 / Tex 150 - Tex 1,68			
Yarn twist range	Tw/" 4 - 56 / T/M 160 - 2,210			
Direction of twist	Z-S twist			
Draft	7.5-80			
Number of spindles:	<ul style="list-style-type: none"> · max 1,824 · min 96 · per section 48 			
Splindles gauge	70 mm - 75 mm			
Ring diameter	36 - 54 mm			
Tubes lenght	180 - 260 mm			
Cylinder dimensions	<ul style="list-style-type: none"> · 27 mm - 30 mm - 27 mm · 27 mm - 30 mm - 27 mm - 27 mm · 30 mm - 30 mm - 30 mm 			
Machine lenght	See p. 16			
Total width:	<ul style="list-style-type: none"> · Doffer retracted 1,140 mm · Doffer estended 1,500 mm 			
Spindles speed	max 25,000 rpm (mechanical)			
Installed power	· Spindles motor	4 kW every 96 spindles / 7.5 kW up to 192 spindles 6.5 kW (until 576 spindles)		
	· Drafting rollers motor	9 kW (from 624 to 1,200 spindles) 13 kW (from 1,344 to 1,824 spindles)		
	· Pantograph upward drive motor	3 kW		
	· Single suction motor	N. spindles	50 Hz	60 Hz
		Up to 576	4 kW	4.6 kW
		624 - 960	5.5 kW	6.3 kW
		1,008 - 1,344	7.5 kW	8.6 kW
		1,392 - 1,584	11 kW	12.6 kW
	· Double suction motor	1,632 - 1,824	15 kW	17.3 kW
		1200 - 1,344	2 x 2.2 kW	2 x 2.5 kW
1,392 - 1,584		2 x 3 kW	2 x 3.5 kW	
1,632 - 1,824		2 x 4 kW	2 x 4.6 kW	
Electrical	3 PH 400/440 Volts + PE Hz 50/60 IEC EN 60204-1 (4,3,2)			
Suction for spindle	4.5 m ³ /h			

MARZOLI WEIGHTING ARM PA3000, MT1 AND MT2

The drafting system is a critical part of the ring spinning frame. If the drafting unit does not work correctly, the yarn quality is irremediably compromised and the productivity of the spinning frame substantially reduced.

Marzoli has therefore developed its own pendulum arm, Marzoli PA3000, to guarantee to the customers that buy a Marzoli spinning frame the following benefits:

- Excellent drafting effectiveness
- High productivity of the spinning section
- Minimum number of ends down
- High yarn quality

These results have been achieved thanks to: the technical excellence of Marzoli weighting arm, the careful selection of all its components.

KEY POINTS

- HIGHER DRAFTING EFFECTIVENESS
- PERFECT CONTROL OF THE FIBERS IN THE DRAFTING AREA
- HIGH YARN QUALITY
- LOWER NUMBER OF ENDS DOWN

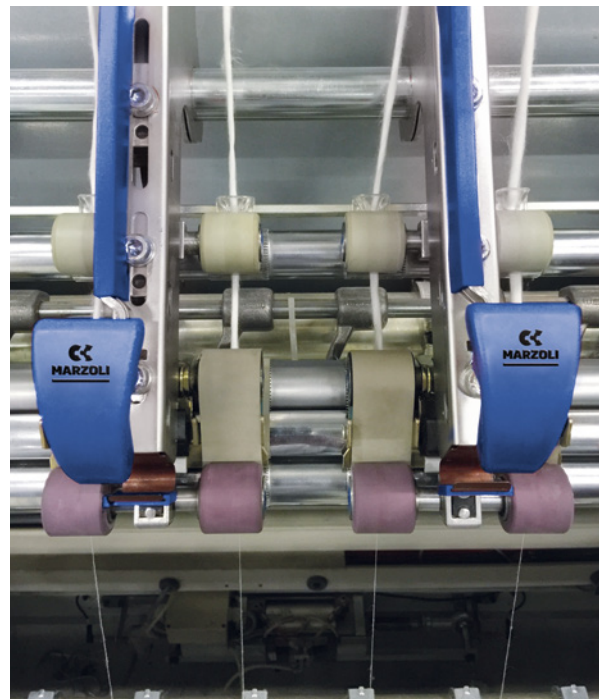

Marzoli weighting arm

Marzoli Arm	Axis	Use
MT1 2025	28mm	Non compact
MT2 2025	28mm	Compact
MT1 2035	35mm	Non compact
MT2 2035	35mm	Compact
MT1 2055	28mm	High draft
PA3000	28mm	Compact

SOFTWARE PLATFORMS

END2END PRODUCTION MANAGEMENT PLATFORM: YARNET

YarNet is Marzoli production management software. It enables the monitoring of production levels, efficiency rates and downtime for both individual machines and the entire spinning mill. Comparisons between machines on selected periods of time are made very simple so that improvement opportunities can be easily identified. YarNet enables the operator to edit production recipes, downloading and uploading them between any machine and their computer. He can also export them in Excel format to share with colleagues as necessary. YarNet gathers and analyses data about production and energy consumption, giving a visual representation of the tradeoffs (kW/kg).

MRM

MRM is Marzoli software to continuously monitor the operating conditions of textile machines. It can identify developing malfunctions before a fault occurs and highlight improvement opportunities on efficiency rates and energy consumption levels. Data about temperature, power consumption, speed and vibration are collected from PLCs (programmable logic controllers) and sensors installed on each machine. The software verifies the monitored parameters are within the nominal operating ranges; it can even adjust for room temperature variations to ensure continuous optimisation. If any parameter is out of tolerance, an automatic email alert is sent to the customer. The customer can also access the dedicated online portal to see information for predictive maintenance and of the overall efficiency of the plant. Through dedicated modules (Optimisation Tools) it is possible to optimise the performance of every machine, in particular on energy consumption and levels of efficiency. If required, Marzoli's customer service team can access the data to diagnose actual and developing problems and recommend appropriate actions.

KEY POINTS

- EASY & FAST CONTROL OF EVERY STAGE OF THE SPINNING PROCESS
- IMPROVED SPEED OF RESPONSE IN PRODUCTION OPERATIONS
- EASY MANAGEMENT OF PRODUCTION RECIPES
- SUPERIOR, EASIER AND FASTER MAINTENANCE

YARNET

Marzoli Production Management

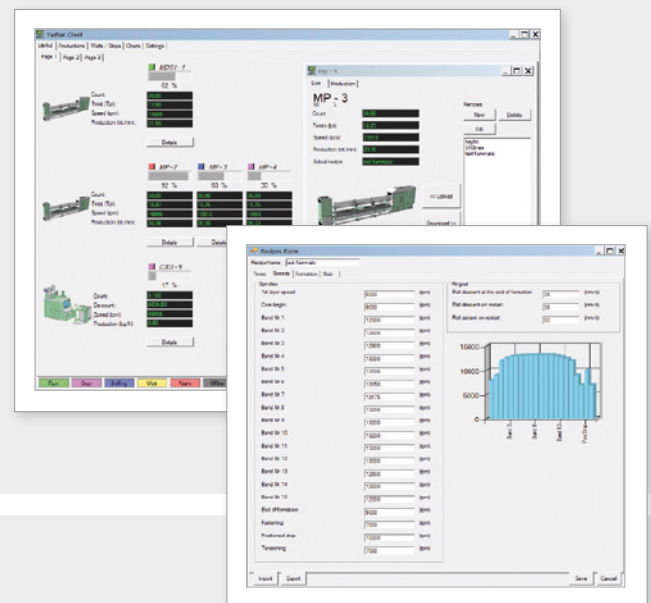

MRM Marzoli Remote Maintenance

IoT Platform by Microsoft®

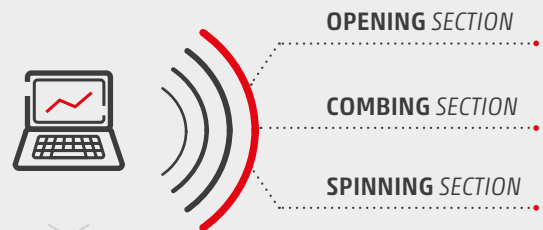

BENEFITS

- Higher productivity
- No machines unplanned downtimes
- Prevention from major machine failures
- Longer plant lifespan
- Higher efficiency
- Complete reliability
- Trouble free spinning experience
- Better maintenance planning

Marzoli Machines Textile S.r.l.
Via Sant'Alberto, 10
25036 Palazzolo sull'Oglio (BS)
Italy
Tel. +39 030 73091
sales@marzoli.it

