

OVERVIEW

TEXTILE COMPONENTS



MARZOLI WEIGHTING ARM PA3000, MT1 AND MT2

The drafting system is a critical part of the ring spinning frame. If the drafting unit does not work correctly, the yarn quality is irremediably compromised and the productivity of the spinning frame substantially reduced.

Marzoli has therefore developed its own pendulum arm, Marzoli PA3000, to guarantee to the customers that buy a Marzoli spinning frame the following benefits:

- Excellent drafting effectiveness
- High productivity of the spinning section
- Minimum number of ends down
- High yarn quality

These results have been achieved thanks to: the technical excellence of Marzoli weighting arm, the careful selection of all its components.

KEY POINTS

- HIGHER DRAFTING EFFECTIVENESS
- PERFECT CONTROL OF THE FIBERS IN THE DRAFTING AREA
- HIGH YARN QUALITY
- LOWER NUMBER OF ENDS DOWN



Marzoli weighting arm

Marzoli Arm	Axis	Use
MT1 2025	28mm	Non compact
MT2 2025	28mm	Compact
MT1 2035	35mm	Non compact
MT2 2035	35mm	Compact
MT1 2055	28mm	High draft
PA3000	28mm	Compact

SPINNING RING

Higher speed of the spinning frame and longer running life of key components

KEY POINTS

- HIGH RETURN ON INVESTMENT
- HIGH SPEED OF THE RING TRAVELER
- LONG RUNNING LIFE OF THE RING AND OF THE TRAVELER
- GREATER PRODUCTIVITY OF THE SPINNING FRAME



Few components on the ring spinning frame are as important as the ring. The ring without doubt is the component that, along with the ring traveler, mostly affect the spinning frame productivity and the end-product quality. In order to ensure that the client with a Marzoli spinning frame relies on the mostly advanced and reliable technology, Marzoli has decided to draw on its superior competence and expertise to develop its own-branded ring.

Marzoli Spinning Ring has been accurately designed in order to minimize the wear and the heat on the traveler, to reach outstanding productivity levels and to guarantee absolute reliability.

Marzoli Spinning Ring MRC is a coated ring with 1100Hv of hardness and a Ra value below 0.05 μ . Its features help to reduce the friction coefficient between the ring and the traveler in order to reach higher speed with lower heating of the components. This, in turns, guarantees a longer running life of the ring and of the traveler, a higher quality of the yarn, lower yarn breakages and a higher productivity of the spinning frame.

Marzoli Spinning Ring MRR features a hardness of around 760 Hv. This ring is available in two versions: a Bright option and a Black option which differs from the former one for its Oxidized coating. Marzoli Spinning Ring MRR constitutes the best solution for regular speed and regular count yarns.

All Marzoli Spinning Rings have been treated with coating and finishing operations that assure:

- Minimum friction, to keep heating to a minimum;
- No wear of the ring, for a longer running life and a greater return on investment;
- Low wear of the traveler.

Marzoli Spinning Rings are suitable for travelers available on the market with the following profiles: Antiwedge and Normal.



MARZOLI TRASH ANALYZER EVO

Marzoli Trash Analyzer EVO is an effective tool for the online analysis of waste for fiber preparation machinery. It can be applied wherever there is a flow of material in a pipeline and, thanks to the integration of a sample weight analysis by weighing pan and the acquisition

KEY POINTS

- ONLINE ANALYSIS OF WASTE
- ADAPTABILITY TO ANY BLOW ROOM OR CARDING MACHINE
- NO MACHINE DOWNTIME

and visual analysis of sample images - it yields a performance index of the overall efficiency in trash removal of the machinery to which it is applied.

MAIN FEATURES

- Simple mechanical structure (slide controlled by pneumatic piston)
- Adaptability to any machine (openers or cards) which includes a waste suction duct.
- No machine downtime due to sampling: the suction works both when the slide is in the test acquisition position and when the machine is unloading the acquired material or normal production
- Intelligence applied in the recognition algorithm: ad hoc image recognition software detects, inside the waste, how much the actual trash is, as well as the amount of good fiber.
- Efficiency of trash removal is the result of a correlation between the quantity and quality (i.e. composition) of actual waste.
- Manual or automatic discharge of the detected sample.
- Possibility of integrating test results with machine production parameters.
- Possibility of integrating test results with MRM platform and YarNet.
- Ability to view test result on onboard display.
- Easy cleaning and slide maintenance by removing grids at the end.
- Easy adjusting height from 1549 to 2549 mm.

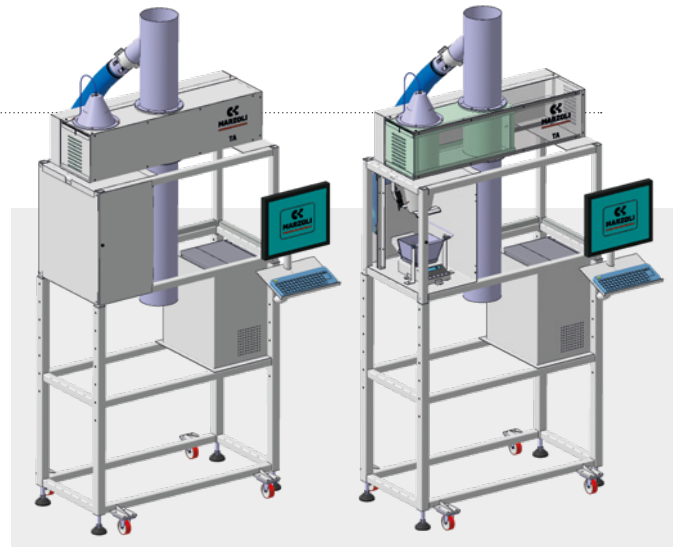

TECHNICAL DATA

Marzoli Trash Analyzer	
Weight scale	0.01 g
Camera resolution	1,280 x 1,024 px
Test duration	up to 120 s
Installed Power	50 W
Net weight	200 kg

MARZOLI RECYCLING WASTE RE-OPENER (RWR-S)

The device, through an effective but gentle opening of the fibers, allows to recover clean waste including roving, slivers, etc.

The application was initially conceived as a complementary device of the IBC to open the roving. The idea was that the material processed and opened by the RWR-S device could be mixed into the same raw blend, in certain percentages, and be reprocessed without any additional activity as no piece of roving was left inside it.

It did not take long before the potential of this application would be extended to the entire spinning process. Marzoli RWR-S can be used to recover good fiber from any type of clean waste.

KEY POINTS

- RECOVERY OF GOOD FIBER FROM ANY TYPE OF CLEAN WASTE
- GENTLE OPENING INTO DIRECTLY REUSABLE FIBER

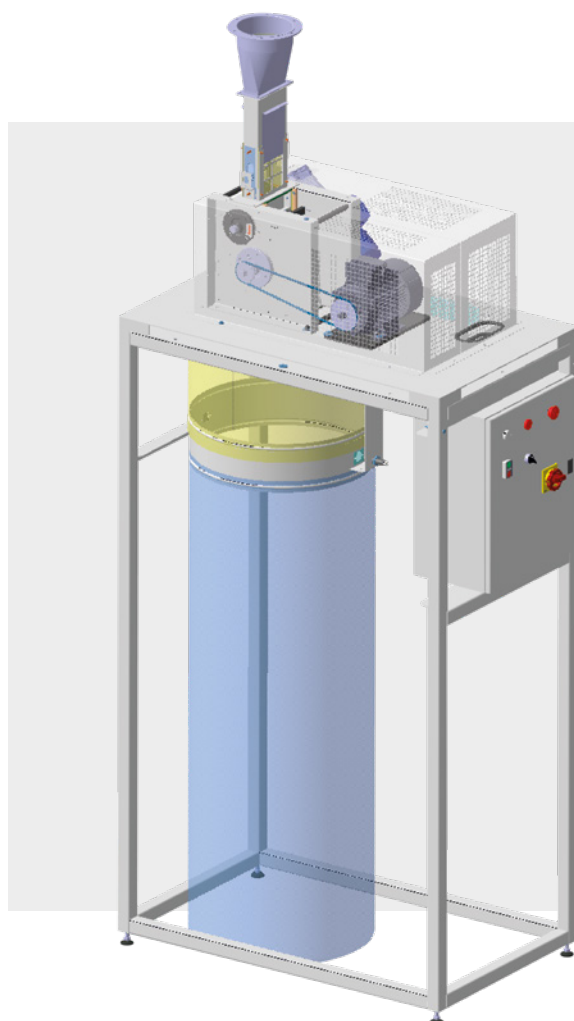

TECHNICAL DATA

Marzoli Recycling Waste Re-Opener (RWR-S)	
Working width	150 mm
Processed material	Cotton / Synthetic
Dimensions	1,050 mm x 650 mm x 2,430 mm
Installed Power	1.37 kW
Net weight	250 kg
Production rate	20 Kg/h

R²F SENSORS

The smart solution to boost productivity on the spinning frame

KEY POINTS

- LOWER SPINDLES DOWNTIME
- PROMPT DETECTION OF SLIPPING SPINDLES
- INFORMATION FOR EFFECTIVE MAINTENANCE OF THE SPINNING FRAME



Marzoli R²F is an innovative sensor, installed on the ring rail of the spinning frame, that continuously monitors the speed of the ring traveler. If a yarn breaks the R²F sensor immediately detects the traveler's stop and the related LED (one LED every 8 spindles, or one every spindle) signals it to the operator, that is passing by, through a flashing light. Furthermore, on the head stock of the spinning frame there are two lamps, one per side, that assume a different color depending on the number of yarn breakages that there are on that side of the spinning frame, so that the operator knows if intervention is required.

On long spinning frames the R²F sensors substantially reduce the number of unnecessary passages of the operator between the spinning frames and the average time on which a spindle is not working therefore boosting the production levels of the spinning frames in a very simple, efficient and effective way.

Beside identifying an idle ring traveler, the R²F also detects the speed of the traveler. This information is very important because it can highlight slipping spindles and twist losses, allowing for a prompt intervention of the maintenance team. In particular the R²F sensors can give, with the

greatest level of accuracy, the following information:

- Status of the spindle (running or idle);
- Which spindles have the highest number of yarn breakages (spindle identification and statistic);
- Which spindles have irregular rotation (spindle slippage);
- Twist (TPM / TPI) of every spindle;
- Speed of every spindle.

All this information is centralized in the machine control unit and is accessible through the MDS1 touch screen display and on the YarNet management system.

Thanks to the installation of the R²F sensors in combination with the YarNet management system the operator can obtain a valuable statistic: number of yarn breakages according to the spinning frame setting, external operating conditions, types of raw materials, types of traveler and traveler's life. This information can help the client to set the machine in order to reduce yarn breakages and slipping spindles while maximizing production.

ACTIVE FLUTE

Innovative system for partial suction

In spinning frames, the suction system used for broken slivers is indispensable, however it requires high energy consumption, also due to the fact that the system remains in operation even when sliver removal is not necessary.

Plus, as machines get longer, energy consumption increases exponentially, becoming one of the main energy cost items.

In order to reduce this cost item, Marzoli has introduced "Active Flute": an innovative system for partial suction, when and where required. Thanks to Marzoli R2F sensors, the active flute system installed on the suction flutes activates or interrupts the air flow by sending commands to the individual section of the machine where the broken sliver is detected. This allows a drastic reduction of energy consumption and improves the efficiency and performance of the entire spinning frame. The final result is an energy savings of up to 70% of total suction consumption.

Furthermore, pairing with Marzoli R2F sensors, reduces the number of unnecessary operator steps between spinning frames and the average spindle downtime, thus increasing the production level of the machine in a simple, efficient and effective way. The active flute system is also designed with retrofitting in mind, allowing energy savings on previously installed Marzoli spinning frames.

KEY POINTS

- REDUCTION OF UNNECESSARY CONSUMPTION
- ENERGY SAVING: UP TO 70%
- AVAILABLE FOR RETROFITTING

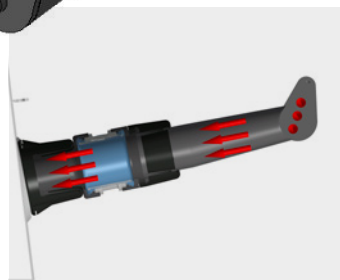

- No broken yarn**
closed active flute:
- Low air flow
 - Low air friction
 - High energy saving

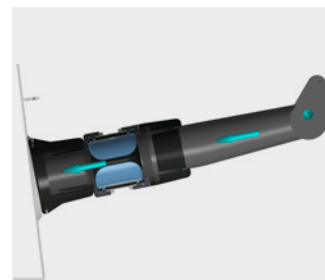

- Broken yarn**
open active flute:
- High air flow to blow fiber

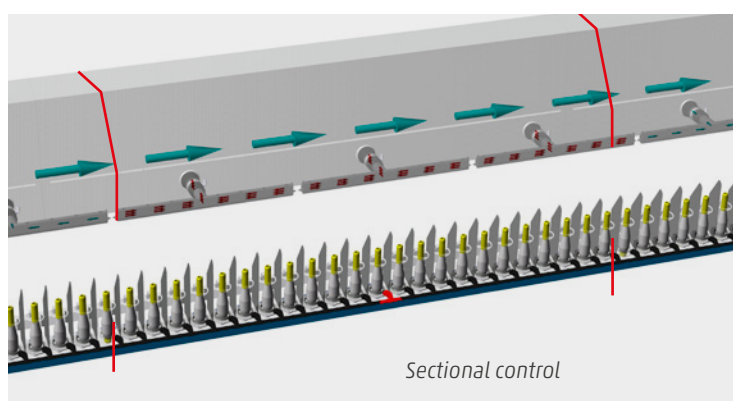

MAC3000

The Compacting System for outstanding quality & flexibility

Despite the high precision of the ring spinning process, ring-spun yarns still present some defects. These defects arise from the fact that the fiber bundle coming out from the front cylinders is wider than the spinning triangle. This entails that edge fibers are usually lost or caught in a disordered way into the yarn. Compact technology allows to reduce the width of the fiber bundle so that all fibers are caught and integrated into the yarn structure. This entails several benefits:

- Reduced hairiness;
- Evenness enhancement;
- Higher strength and elongation of the yarn;
- Less variations in strength and elongation values;
- Lower required twist on the spinning frame (which allows higher production);
- Reduced fiber fly in weaving and knitting operations (which grants fewer defects on the fabrics and higher efficiency of the machines);
- Enhanced fabrics properties (fabric strength, abrasion resistance, pilling behavior, visual and tactile characteristics).

Thanks to accurate technical design, careful selection of components and several tests with selected partners, Marzoli has developed a state-of-the-art solution for yarn compaction. The data witness outstanding quality results with the highest degree of reliability.

KEY POINTS

- OUTSTANDING QUALITY RESULTS
- HIGHEST DEGREE OF RELIABILITY
- SUPERIOR FLEXIBILITY
- LOW MAINTENANCE

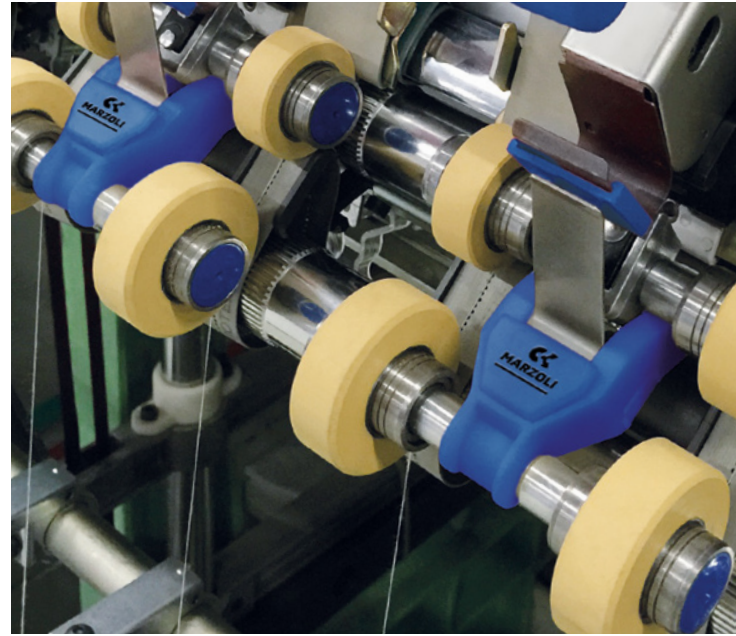

Advantages of Marzoli solution:

- Outstanding yarn quality;
- Low investment cost;
- Low production cost;
- Great flexibility (Marzoli compact device can be easily installed and uninstalled from the MDS1 spinning frame);
- Suitable with various types of fibers: carded cotton, combed cotton, synthetics, blends and technical fibers.
- Reduced cleaning and maintenance due to its design.

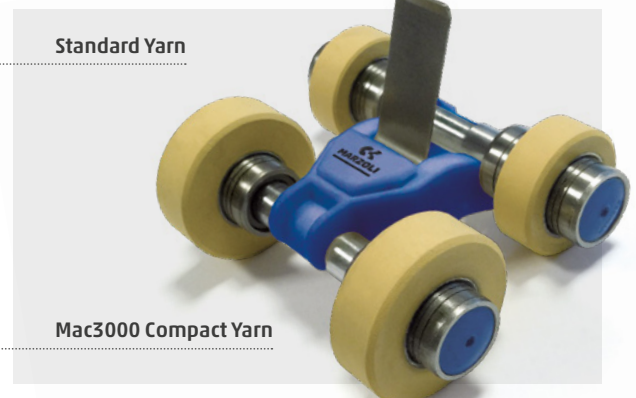

MARZOLI REVOLVER EXCHANGER (MRE)

Marzoli MRE (Marzoli patent) represents a new solution to boost efficiency and flexibility in the exchange and cleaning of empty tubes with full bobbins on automated transport systems. With Marzoli MRE two full bobbins are taken from the doffer rail of the roving frame or from the trolley coming from the roving frame. At the same time two dirty tubes coming from the spinning frames are taken from the transport rail. After an intermediate step in which the tubes are cleaned by 2 integrated IBCs, Marzoli MRE places the empty tubes on the doffer rail/trolley to be sent to the roving frame and the full bobbins on the transport rail to feed the ring frames. Marzoli MRE has a considerable effect on the reduction of time wasted in exchanging and cleaning of bobbins. The process can be done two times faster than single exchangers, an aspect that can underpin higher efficiency rates on long roving frames and/or when coarse counts are produced.

Marzoli MRE can be installed on roving frames of either gauge, 110mm or 130mm, and exchange bobbins with transport systems of any manufacturer and of any gauge. Marzoli MRE entails the following benefits:

- Superior efficiency and easy handling (cleaning and exchanging of 360 bobbins /hour).
- Higher efficiency on long roving machines and/or with coarse roving counts.
- Minimum space required
- Installable on either head stock or tail stock for an easier design of the transport rail and IBC suction duct
- Full automation
- Available on Marzoli FT60 and FT70 or as a stand alone system

KEY POINTS

- CLEANING & EXCHANGING OF 2 BOBBINS AT A TIME
- 360 BOBBINS/HOUR (2 TIMES FASTER THAN SINGLE EXCHANGERS)
- INSTALLABLE ON ROVING FRAMES OF EITHER GAUGE 110 mm OR 130 mm OR AS A STAND ALONE PRODUCT
- AVAILABLE FOR TRANSPORT SYSTEMS WITH ANY OF THE MAIN AVAILABLE GAUGES

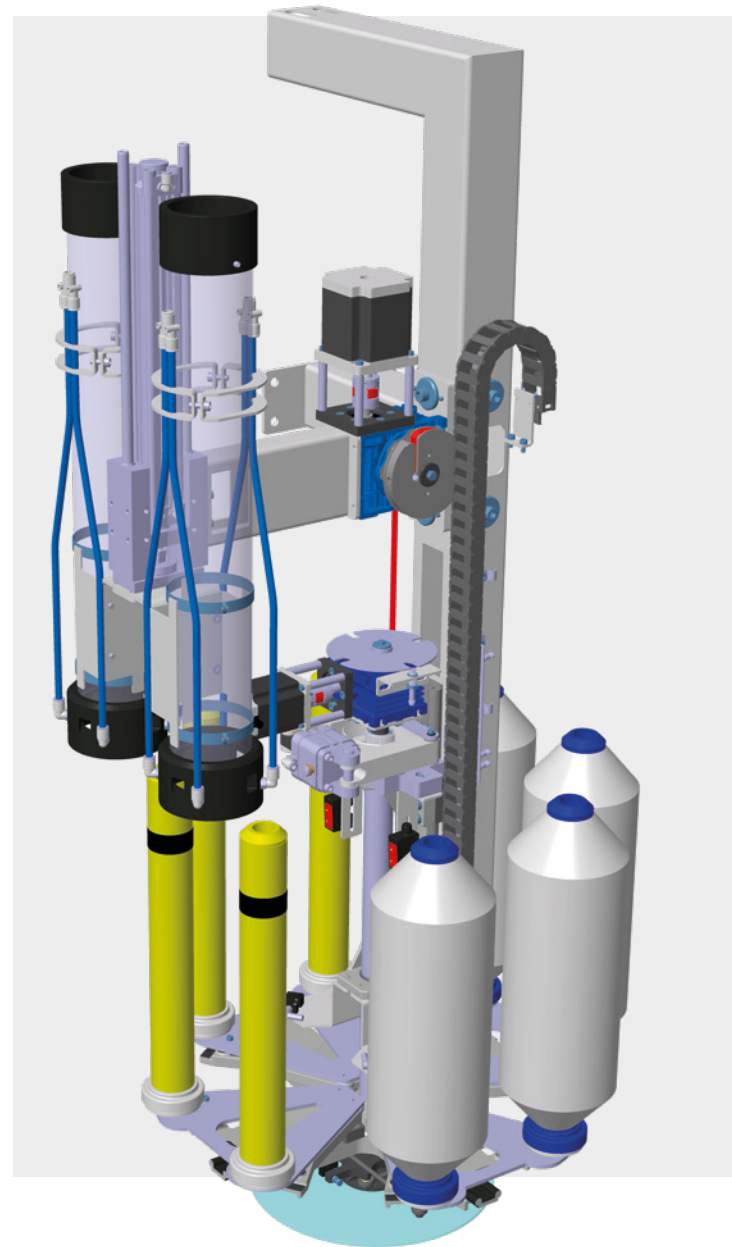

R²S SENSORS

The smart solution to boost productivity on the roving frame



The Marzoli R²S system with statistics for roving break detection controls each spindle using a reflective photocell which constantly monitors the presence of the roving, promptly signalling any breakage by means of serial communication to the control board, which immediately sends a stop signal to the bench along with the number of the broken roving. Each sensor is equipped with a flashing red light, visible from afar, easily indicating the position that requires operator intervention for refitting.

The R²S system with statistics displays a series of graphically tabulated information on the bench operator panel, allowing the maintenance operator to easily identify which spindles are most prone to breakage and promptly intervene, improving efficiency and maximising production.

An advanced algorithm also detects breakages due to poor manual refitting by the operators, can changes and new restarts, in order to only count breakages that are relevant for the maintenance operator. The targeted and detailed analysis of breakage status is shown by formation, shift, day and overall. Combined with the Yarnet Management and/or DRM system, the R²S system can record and save the breakage history.

In addition, interaction between the R²S system and BrainBox makes it possible to further increase productivity, modifying the machine set-up to increase its yield and reduce breakages.

MARZOLI INTENSIVE CLEARING BRUSH (ICB)

Designed and developed for spinning mills that process different color batches, where effective cleaning of the card and contamination avoidance are major challenges, Marzoli ICB, Intensive Clearing Brush, is an automatic device that cleans the carding strips installed on the revolving flats in great depth.

It comprises a frequency-controlled brush and an integrated suction system to remove all fiber fly and dust. The brush penetrates the carding strip to remove the fiber stuck in depth to avoid any contamination on the next batch.

KEY POINTS

- INTENSIVE AND IN-DEPTH CLEANING OF CARDING STRIPS
- INTEGRATED SUCTION SYSTEM TO REMOVE FIBER FLY AND DUST



MAIN FEATURES

- Brush with nylon bristles that penetrate deep inside the tips of the revolving flats
- In case of frequent batch change:
 - a) Contamination is minimized
 - b) Maintenance and cleaning operations are faster
- Integrated suction for removal of fiber and dust
- Brush activation by means of a service procedure allows visual control by the operator of the brush cleaning action
- Simplicity of putting the brush into working / resting position by means of a lever system with central handle
- Mechanical stop to lock positions in work / at rest
- Configurable solution for carding flats with a 40 inch or 60 inch working width
- Modular brush speed under inverter according to the desired degree of cleaning
- The brush is installed in an area of the machine that does not complicate access to normal cleaning and maintenance operations

TECHNICAL DATA

Marzoli Intensive Clearing Brush (ICB)	
Working width	40" - 60"
Brush diameter	109 mm
Installed Power	0,12 kW
Net weight	20 kg

SOFTWARE PLATFORMS: YARNET

KEY POINTS

- ONE SOFTWARE FOR THE ENTIRE SPINNING LINE
- EASY & IMMEDIATE MONITORING OF EVERY MACHINE
- RECIPES EDITING & UPLOADING
- POWER MANAGEMENT FUNCTION

YARNET
Marzoli Production Management



YarNet is Marzoli production management software. It allows to register and elaborate all production data, operating conditions and technological parameters of the machines in real time in one simple, intuitive and well-structured interface and allows the user to interact directly with each and every machine

of the spinning plant by downloading, editing and uploading any production recipe. The centralization of all the information about the spinning process enables the client to have everything under control in any moment and to manage production from his office.

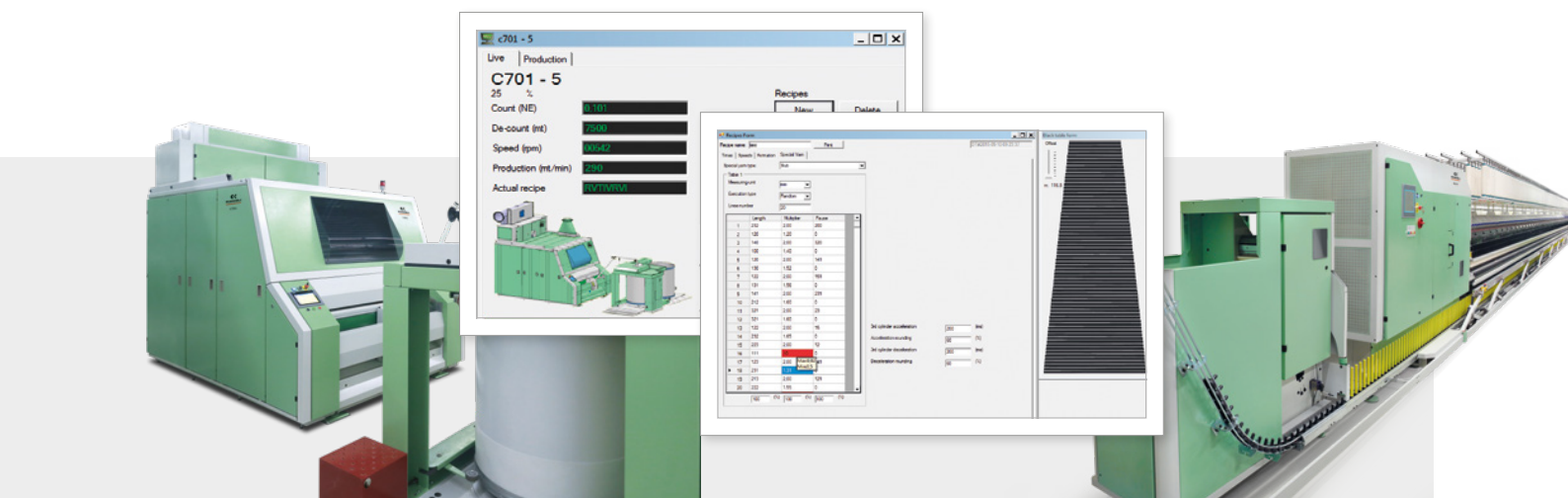

The interface is organized in 5 different pages. The Layout page allows to monitor the entire spinning mill: it lists all the machines and for each one of them it showcases the real-time production data and technological parameters (e.g. count, twist, speed, production, etc.). By clicking on the details button located under the parameters of the machine, the user can access the recipes saved for that machine.

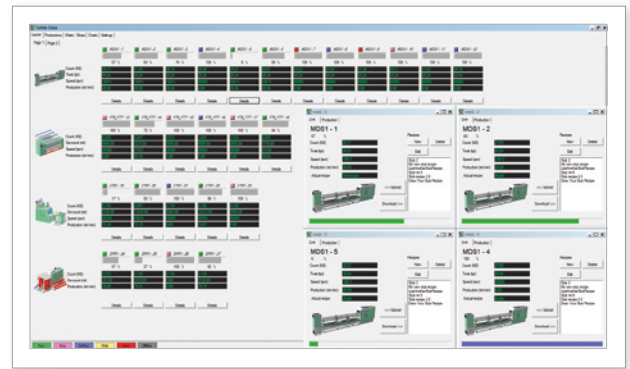

The Production and Charts pages display production levels and efficiency levels of the machines and of the entire mill. The data can be filtered in several ways (e.g. shift, machine, product, etc.). The Waits & Stops page displays the causes of stops for each machine with related frequencies giving valuable information for maintenance.

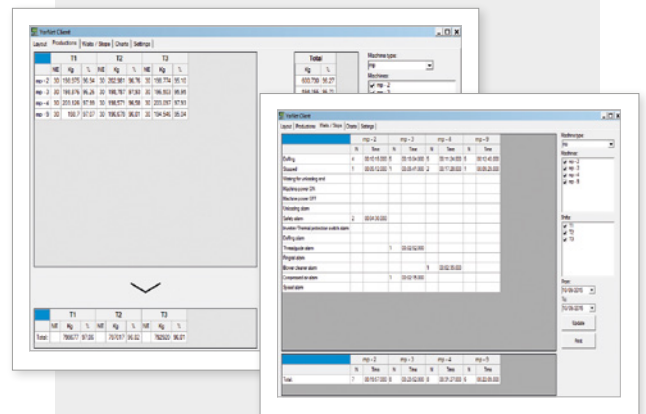

Embedded in YarNet there is also a power management function which elaborates the data about production and energy consumption and generates graphs that identify the trade-offs (kW/kg). The client can therefore adjust production levels in order to minimize energy consumption.

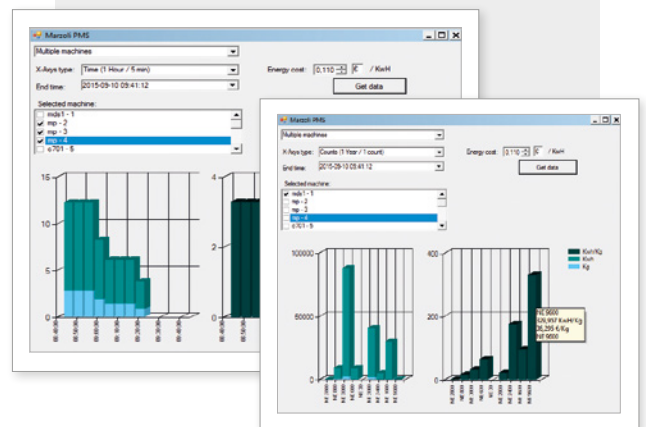

OPENING SECTION

- Openers & Cleaners
- Mixers & Blenders
- Card



COMBING SECTION

- Draw Frames
- Lap Winder
- Comber
- Lap Transport



SPINNING SECTION

- Roving Frame
- Ring Spinning Frame
- Bobbin Transport System



SOFTWARE PLATFORMS: MRM

KEY POINTS

- CONTINUOUS MONITORING OF CRITICAL PARAMETERS
- IMMEDIATE WARNING IN CASE OF DEVIATIONS FROM STANDARDS
- PREDICTIVE MAINTENANCE

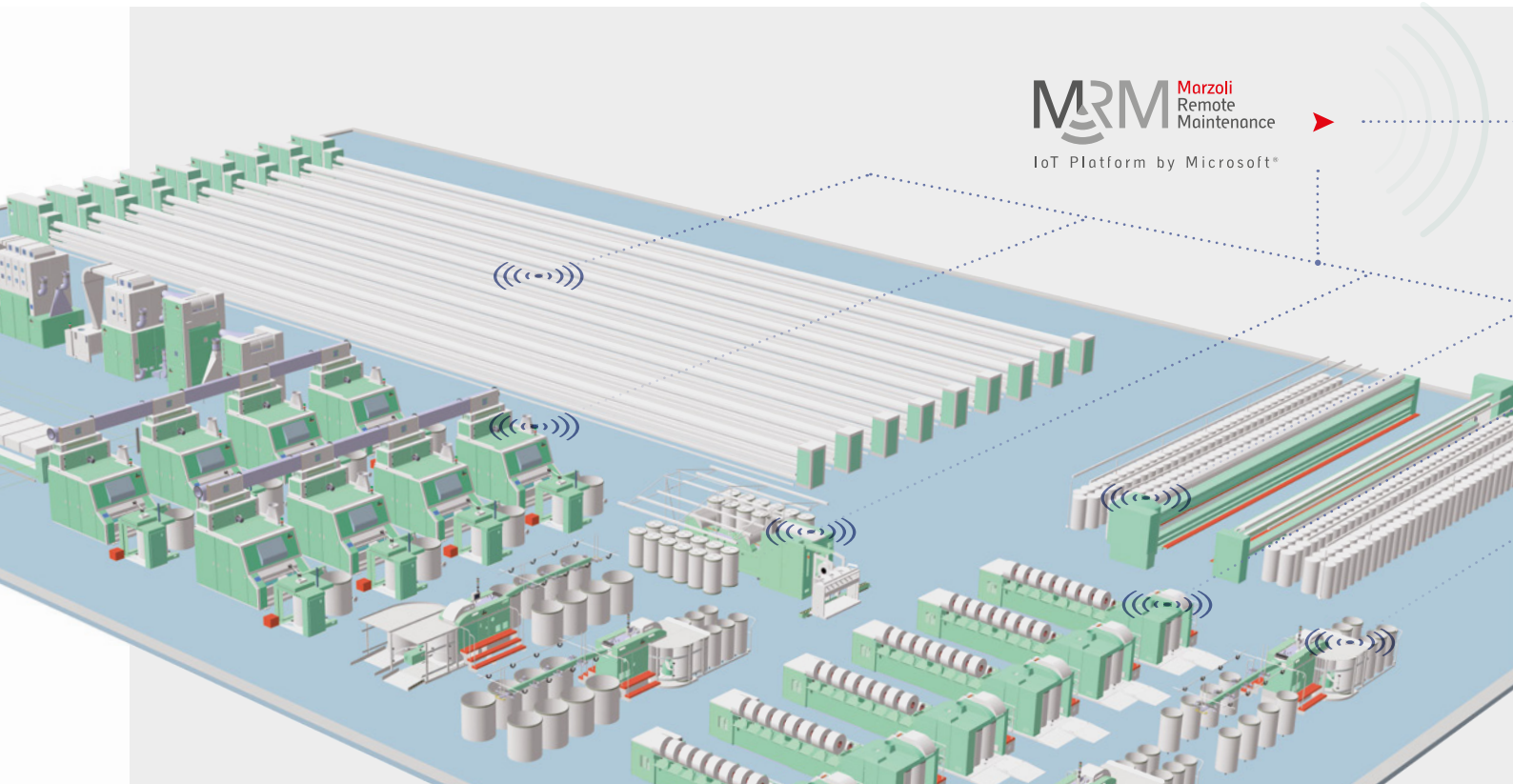

MRM is an innovative software platform developed by Marzoli that continuously analyzes the symptomatic data gathered by processors and sensors installed in critical parts of the machines to constantly monitor their efficiency. The data about temperatures, power consumption, pressures, speeds and vibrations are gathered and, through a gateway, are sent to the Azure Cloud provided by Microsoft.

The data are then analyzed through special algorithms developed by Marzoli which verify that the monitored parameters are inside the machine nominal operating ranges according to the machine working conditions.

If anyone of them is not, an automatic email alert is sent to the client's addresses registered in the system.

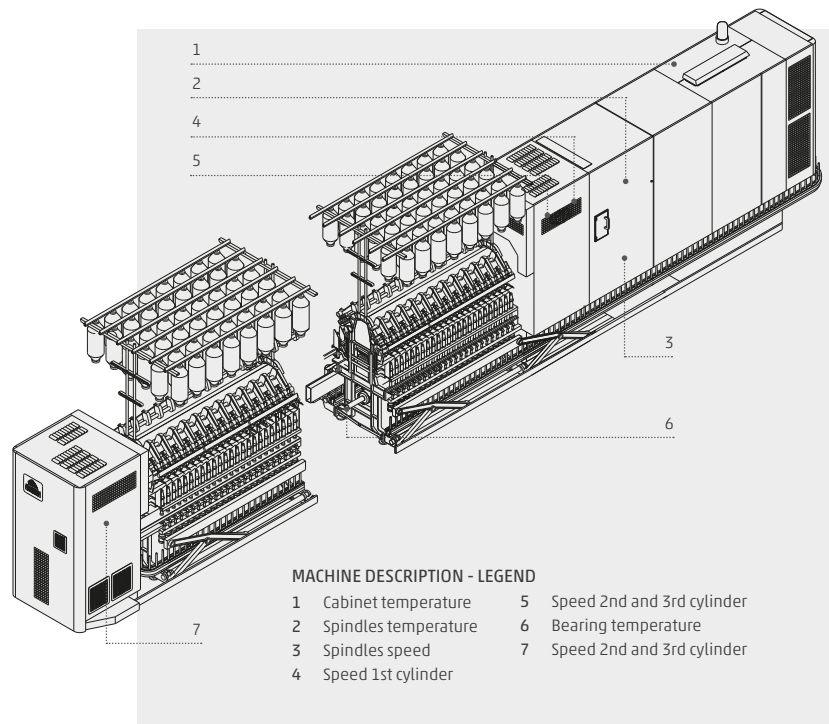

- MODULES FOR OPTIMIZATION OF ENERGY CONSUMPTION AND EFFICIENCY LEVELS
- REMOTE ASSISTANCE BY MARZOLI'S CUSTOMER SERVICE

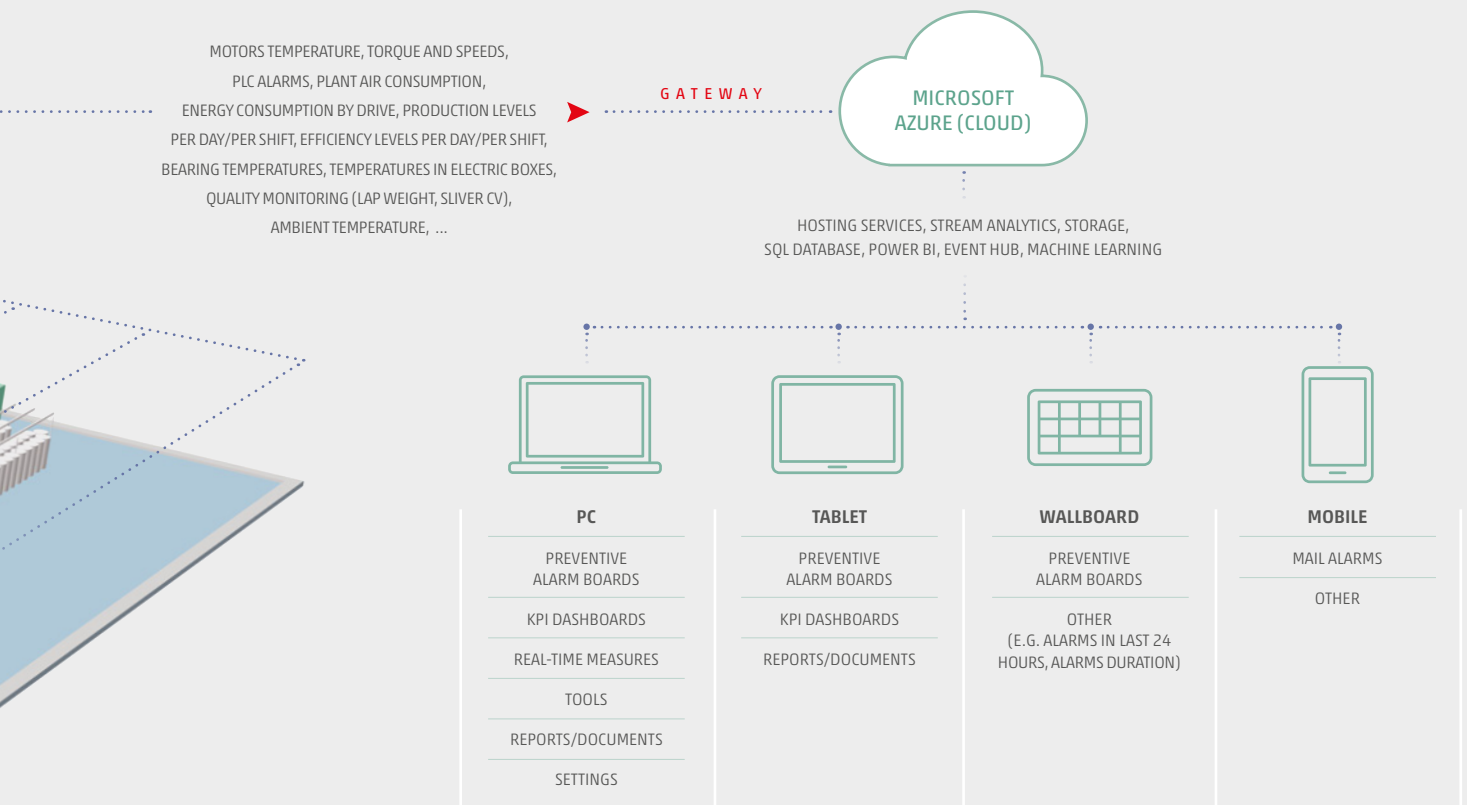

The client can always access the dedicated portal where it is possible to see the information for predictive maintenance of the machines and of the overall efficiency of the plant.

Through dedicated modules (Optimization Tools) included in the software it is possible to optimize the performances of every machine, in particular on energy consumption and efficiency levels.

Marzoli's customer service can access, if necessary, the data of the customer's machines to diagnose an eventual problem and communicate the necessary steps to solve it.

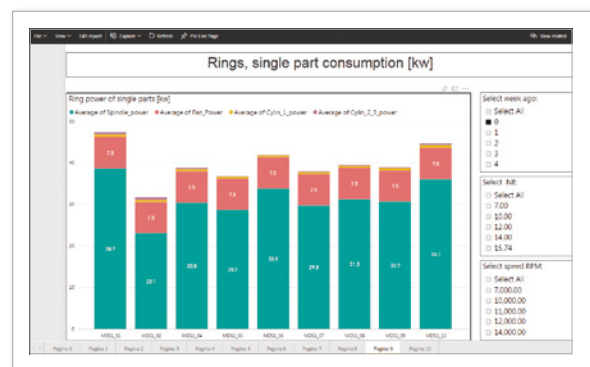

Marzoli Machines Textile S.r.l.
Via Sant'Alberto, 10
25036 Palazzolo sull'Oglio (BS)
Italy
Tel. +39 030 73091
sales@marzoli.it

